

# WEDHOLMS AB ELDOKUMENTATION ELECTRIC DOCUMENTATION

APPARATMONTAGE A1 Enl.320651 (EQUIPMENT A1)  
 APPARATLISTA A1 Enl.320652 (EQUIPMENT LIST A1)  
 ANSLUTNINGAR ARGOS Enl.320653 (CONNECTION ARGOS)  
 KRETSSCHEMA Enl.320654-320655 (CIRCUIT DIAGRAM)  
 KABELLISTA Enl.320656 (CABLE LIST)  
 YTTRE FÖRBINDNING Enl.320657-320659 (EXTERNAL CONNECTION)  
 SKARVLÅDA DF95 Enl.320660 (CONNECTION-BOX DF95)

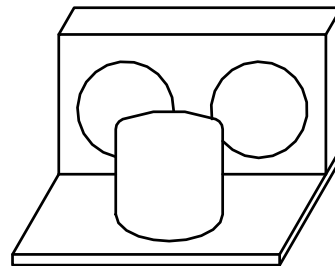

|                                   |          |       |           |        |                  |
|-----------------------------------|----------|-------|-----------|--------|------------------|
| Ritad                             | Datum    | Godk. | Stand.gr. | Skala  | Sammanst.ritn.nr |
| tba                               | 13-02-01 | AH    |           | .      | .                |
| Box2003 för Argos styrning        |          |       |           |        | Order nr         |
| Box2003 for Argos control         |          |       |           |        | .                |
| Argos and 1comp+Base K,L,M,N or P |          |       |           |        | Ersätter         |
|                                   |          |       |           |        | Ersatt av        |
| <b>Wedholms</b><br>Wedholms AB    |          |       | Ref.nr    | Utgåva | Ritn.Nr          |
|                                   |          |       | .         | A      | 320650           |

A1

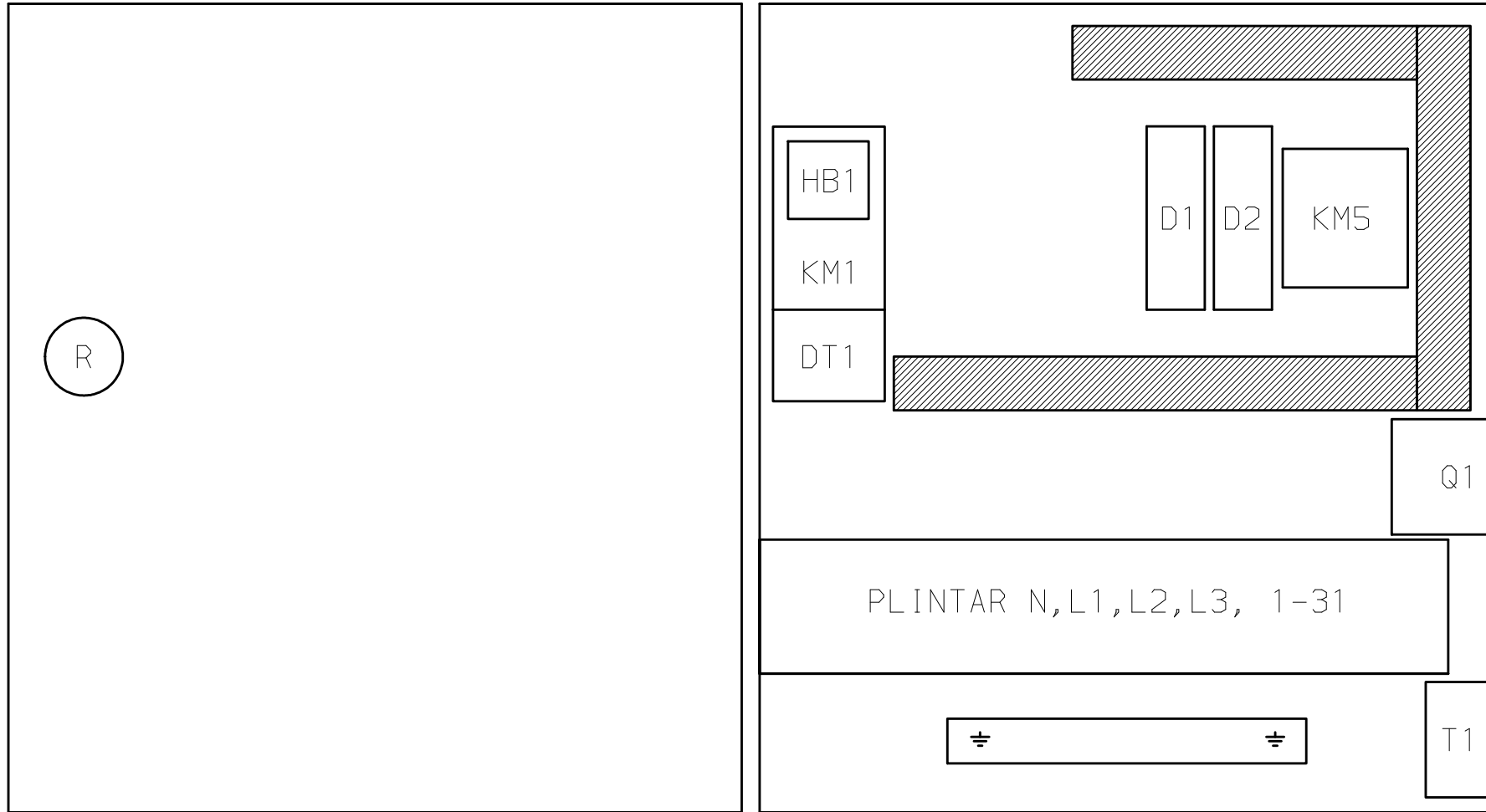

|                                |          |       |            |       |                    |
|--------------------------------|----------|-------|------------|-------|--------------------|
| Ritad                          | Datum    | Godk. | Stand. gr. | Skala | Sammanst. ritn. nr |
| LON                            | 16-05-16 | AH    |            | .     | .                  |
| Box2003 för Argos styrning     |          |       |            |       | Order nr           |
| Box2003 for Argos control      |          |       |            |       | .                  |
| Apparatmontage A1/Equipment A1 |          |       |            |       | Ersätter           |
|                                |          |       |            |       | Ersatt av          |
| <b>Wedholms</b>                |          |       |            |       | Ritn. Nr           |
| Wedholms AB                    |          |       |            |       | D 320651           |

| ANTAL | POST | BETECKNING                | FABRIKAT  | ANMÄRKNING  | REV. |
|-------|------|---------------------------|-----------|---|------|
| 1     | DT 1 | LRD 14 or LRD 21 or LRD22 | SCHNEIDER | ÖVERSTRÖMSRELÄ 7-10A (12-18A) (16-24A) (BREAKER COMPRESSOR) |      |
| 1     | R    | XB5 AA86102               | SCHNEIDER | ÅTERSTÄLLNING ÖVERSTRÖMSRELÄ                                |      |
| 1     | KM 1 | LC1 D25                   | SCHNEIDER | KONTAKTOR (CONTACTOR COMPRESSOR)                            |      |
| 1     | KM 5 | LC1K K0910 M72            | SCHNEIDER | MINI KONTAKTOR (CONTACTOR CLEANING PUMP)                    |      |
| 1     | D1   | A9F0410                   | SCHNEIDER | AUTOMATSÄKRING 2 POL (BREAKER FANS/CLEANING PUMP)           |      |
| 1     | D2   | A9F0406                   | SCHNEIDER | AUTOMATSÄKRING 2 POL (BREAKER CONTROL/ARGOS)                |      |
| 1     | T1   | T85 TYP600                | DIEHL     | TIDUR (TIMER)   |      |
| 1     | HB1  | LADN20                    | SCHNEIDER | HJÄLPBLOCK (AUXILIARY BLOCK)                                |      |
| 1     | Q1   | PSA032 AK341E             | EMAS      | HUVUDBRYTARE (MAIN SWITCH)                                  |      |
|       |      |                           |           |   |      |
|       |      |                           |           |   |      |
|       |      |                           |           |   |      |
|       |      |                           |           |   |      |
|       |      |                           |           |   |      |
|       |      |                           |           |   |      |
|       |      |                           |           |   |      |
|       |      |                           |           |   |      |
|       |      |                           |           |   |      |
|       |      |                           |           |   |      |
|       |      |                           |           |   |      |
|       |      |                           |           |   |      |
|       |      |                           |           |   |      |
|       |      |                           |           |   |      |
|       |      |                           |           |   |      |
|       |      |                           |           |   |      |
|       |      |                           |           |   |      |
|       |      |                           |           |   |      |
|       |      |                           |           |   |      |
|       |      |                           |           |   |      |
|       |      |                           |           |   |      |
|       |      |                           |           |   |      |
|       |      |                           |           |   |      |
|       |      |                           |           |   |      |
|       |      |                           |           |   |      |
|       |      |                           |           |   |      |
|       |      |                           |           |   |      |
|       |      |                           |           |   |      |
|       |      |                           |           |   |      |
|       |      |                           |           |   |      |
|       |      |                           |           |   |      |
|       |      |                           |           |   |      |
|       |      |                           |           |   |      |
|       |      |                           |           |   |      |
|       |      |                           |           |   |      |

|  |                                  |                            |                                |                            |   |
|--|----------------------------------|----------------------------|--------------------------------|----------------------------|---|
| <small>Ritad</small><br>LON  | <small>Datum</small><br>16-05-16 | <small>Godk.</small><br>AH | <small>Stand. gr.</small><br>. | <small>Skala</small><br>.  | <small>Sammonstr. ritn. nr</small><br>. |
| Box2003 för Argos styrning<br>Box2003 for Argos control<br>Apparatlista A1/Equipment list A1 |                                  |                            |                                |                            | <small>Örden nr</small><br>.            |
| <b>Wedholms</b><br><small>Wedholms AB</small>  |                                  |                            |                                |                            | <small>Ersätter</small><br>.            |
| <small>Ref. nr</small><br>.  |                                  |                            |                                | <small>Utgåva</small><br>D | <small>Ritn. Nr</small><br>320652       |

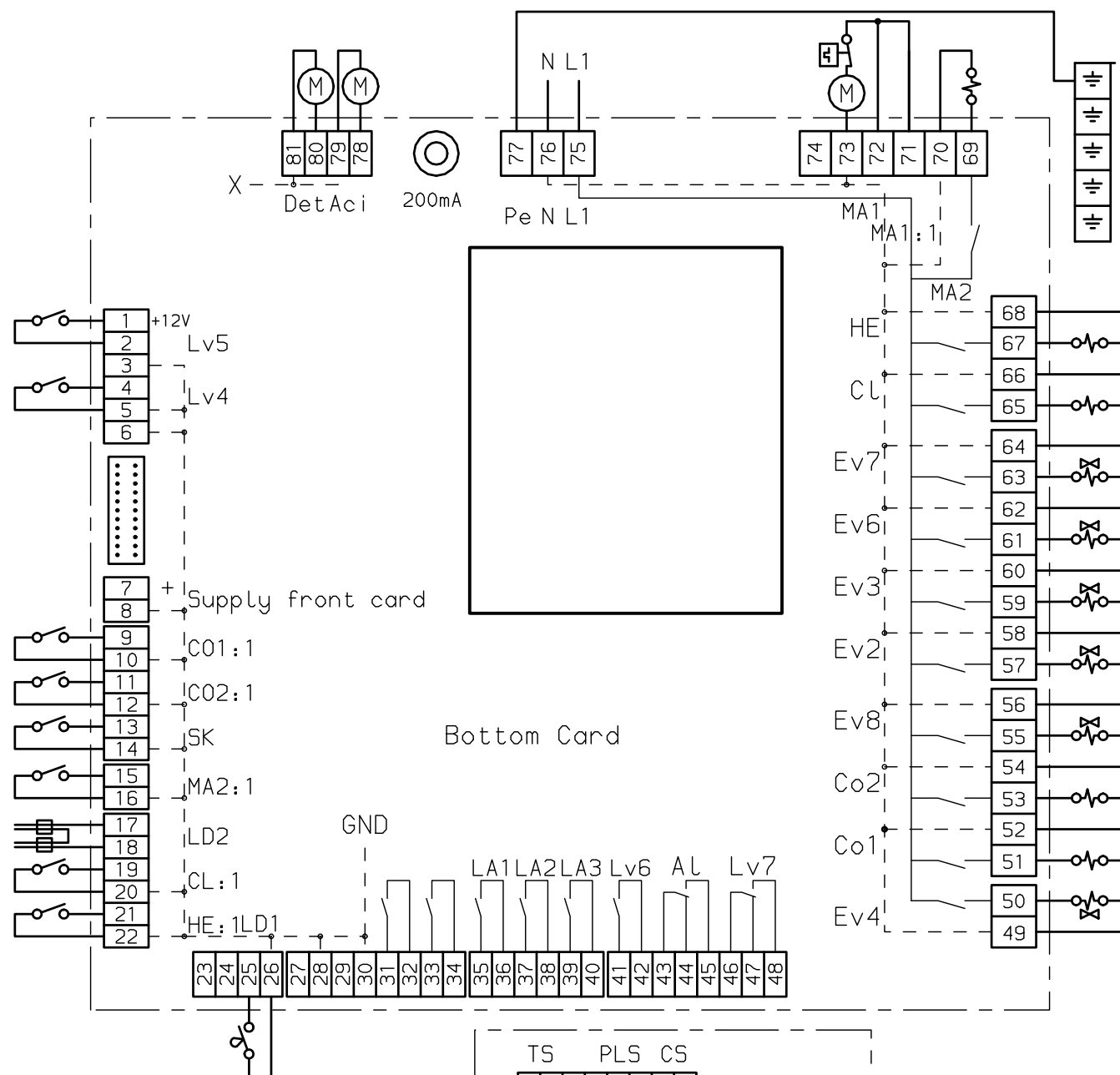

Outputs:

- MA1 Agitator
- MA2 Milk-pump
- EV2 Solenoid valve Hot Water
- EV3 Solenoid valve Cold Water
- EV4 Solenoid valve Outlet Valve Tank
- EV6 Solenoid valve Drain Valve No 1
- EV7 Solenoid valve Drain Valve No 2
- EV8 Solenoid valve Capacity Regulator
- CL1 Contactor Cleaning Pump
- C01 Contactor Compressor 1
- C02 Contactor Compressor 2
- HE Contactor Heater
- DET Dos Pump Detergent
- ACI Dos Pump Desinfection
- AL1 Alarm
- LV6 "Emptying/cleaning" signal to robot
- LV7 "Cleaning on" signal to robot
- LA1 Light cooling on
- LA2 Tankguard red light
- LA3 Tankguard green light

Inputs:

- MA:1 Feedback Agitator
- MA:2 Feedback Milkpump
- C01:1 Feedback Cotactor Compressor 1
- C02:1 Feedback Contactor Compressor 2
- CL:1 Feedback Contactor Cleaning Pump
- HE:1 Feedback Contactor Heater
- SK Start cooling
- LD1 Level Indicator Washing
- LD2 Conductive Sensor Detergent
- LV4 Position Outlet Valve
- LV5 Position Filling Valve robot
- TS Sensor Temperature Tank
- PLS Level Sensor Tank
- CS Conductive Sensor Cleaning

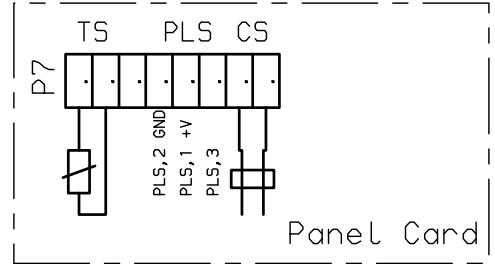

|                                    |          |       |           |        |                    |
|------------------------------------|----------|-------|-----------|--------|--------------------|
| Ritad                              | Datum    | Godk. | Stand.gr. | Skala  | Sammanst.r.itn.nr. |
| tba                                | 13-02-01 | AH    |           | .      |                    |
| Box2003 för Argos styrning         |          |       |           |        | Order nr           |
| Box2003 for Argos control          |          |       |           |        | .                  |
| Plintar Argos/Terminal block Argos |          |       |           |        | Ersätter           |
| Ersatt av                          |          |       |           |        | .                  |
| <b>Wedholms</b>                    |          |       | Ref.nr    | Utgåva | Ritn.Nr            |
| Wedholms AB                        |          |       | .         | A      | 320653             |

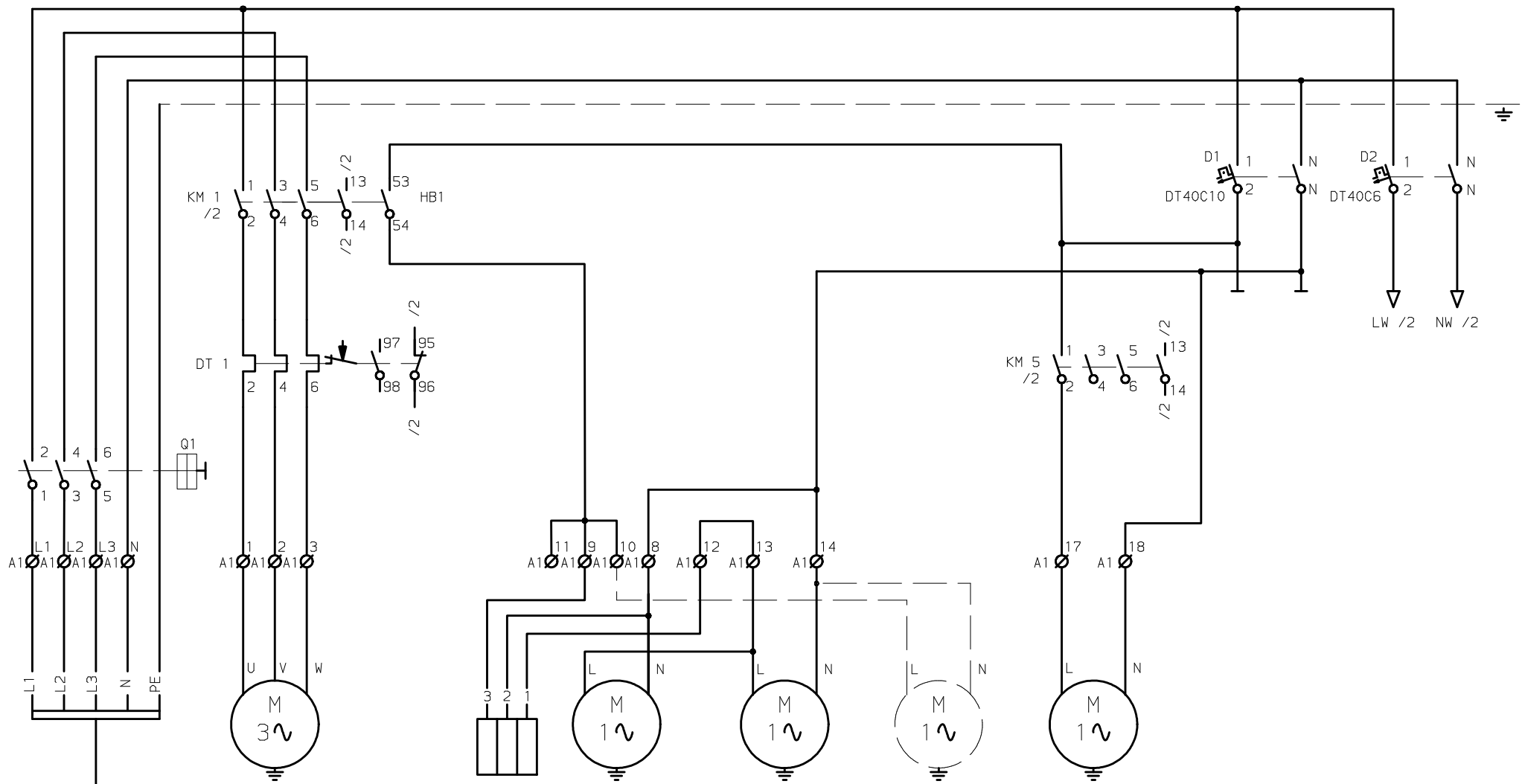

M 1  
KOMPRESSOR  
COMPRESSOR

R 11  
REGULATOR  
FAN-REGULATION  
JOHNSON CONTROLS  
TYPE P215PR-9200

M 10  
FLÄKT 1  
FAN 1

M 11  
FLÄKT 2  
FAN 2

MC5  
PUMP INTERPAC (OPTION)  
PUMP INTERPAC (OPTION)

M 5  
DISKPUMP  
CLEANING PUMP

FLÄKTAR OCH PUMPAR  
FANS AND PUMPS  
MANÖVERSPÄNNING ARGOS  
CONTROL ARGOS

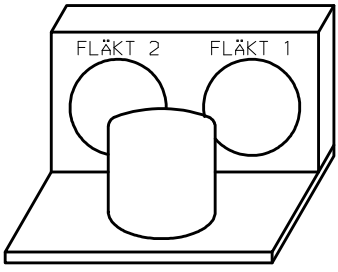

MATNING 3x400 PEN  
MAIN CABLE

|  |                   |             |            |          |                     |
|--|-------------------|-------------|------------|----------|---------------------|
| Ritad<br>LÖN   | Datum<br>16-05-17 | Godk.<br>AH | Stand. gr. | Skala    | Sammanst. ritn. nr. |
| Box2003 för Argos styrning<br>Box2003 for Argos control<br>Kretsschema/Circuit diagram 1 (2) |                   |             |            |          | Order nr.           |
| Ersätter   |                   |             |            |          | Ersatt av           |
| Wedholms<br>Wedholms AB  |                   |             |            | Ref. nr. | Utgåva<br>D         |
|  |                   |             |            |          | Ritn. Nr.<br>320654 |

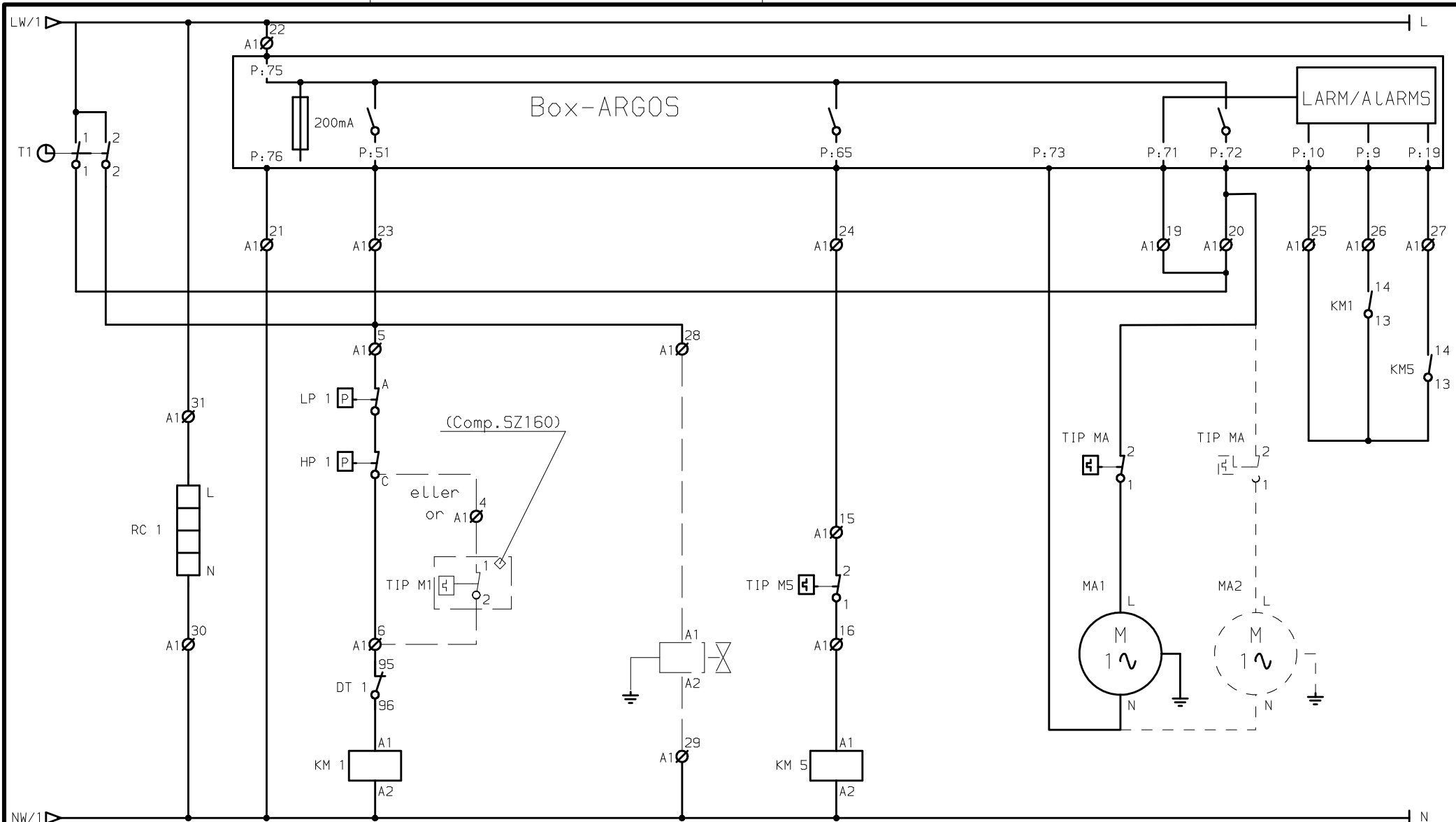

VEVHUSVÄRMARE  
CRANKCASE HEATER

KOMPRESSOR  
COMPRESSOR

MAGNETVENTIL (OPTION)  
SOLENOID VALVE (OPTION)

DISKPUMP  
CLEANING PUMP

RÖRVERK  
AGITATOR

RÖRVERK / 8000L ->  
AGITATOR / 8000L ->

|  |                   |             |               |             |                          |
|--|-------------------|-------------|---------------|-------------|--------------------------|
| Ritad<br>LÖN   | Datum<br>16-03-10 | Godk.<br>AH | Stand. gr.    | Skala<br>.  | Sammanst. ritn. nr.<br>. |
| Box2003 för Argos styrning<br>Box2003 for Argos control<br>Kretsschema/Circuit diagram 2 (2) |                   |             |               |             | Örder nr.<br>.           |
| Ersätter<br>.  |                   |             |               |             | Ersatt av<br>.           |
| Wedholms<br>Wedholms AB  |                   |             | Ref. nr.<br>. | Utgåva<br>C | Ritn. Nr.<br>320655      |

| KABEL<br>NUMMER | ANSLUTNING<br>A  | KABELTYP, AREA          | ANSLUTNING<br>B | ANMÄRKNING  | REV. |
|-----------------|------------------|-------------------------|-----------------|---|------|
| 1               | FÖRDELN. CENTRAL | REV 5G1.5 (5G2.5) (5G4) | A1              | INKOMMANDE MATNING 3X400V P.EN 16A or 25A/MAIN CABLE            |      |
| 2               |                  |                         |                 |   |      |
| 3               | A1               | RKK 4G2.5               | M 1             | KOMPRESSOR/COMPRESSOR   |      |
| 4               | A1               | RKK 3G1                 | HP1/LP1         | PRESSOSTATER KOMPRESSOR/SAFETY PRESSOSTAT HIGH/LOW              |      |
| 5               | A1               | RKK 3G1.5               | M 10            | FLÄKT 1/FAN 1   |      |
| 6               | A1               | RKK 3G1.5               | M 11            | FLÄKT 2/FAN 2   |      |
| 7               | A1               | RKK 3G1                 | R 11            | REGLERING FLÄKT 1/2 /REGULATION FAN 1/2 (D350,D420) and 1 D500  |      |
| 8               | (A1)             | (RKK 3G1.5)             | (M1)            | (KOMPRESSOR TERMISKT SKYDD SZ160,175/THERMALS PROTECTION COMP.) |      |
| 9               | A1               | RKK 3G1                 | R 12            | REGLERING FLÄKT 2 (FLÄKT D500)/REGULATION FAN 2 (FAN D500)      |      |
| 10              | Box Argos        | RKK 3G1.5               | MA              | RÖRVERK/AGITATOR  |      |
| 11              | A1               | RKK 5G1.5               | M 5             | DISKPUMP MED INBYGGT TERMISKT SKYDD/CLEANING PUMP               |      |
| 12              | (A1)             | (FKK 3G1.5)             | (MC5)           | (INTERPAC OPTION)   |      |
| 13              | A1               | 10G0.75                 | Box Argos       | INTERFACE KABEL A1-ARGOS/INTERFACE CABLE A1-ARGOS               |      |
| 14              | A1               | RKK 3G1.5               | RC 1            | VEVHUSVÄRMARE KOMPRESSOR/CRANKCASE HEATER COMPRESSOR            |      |
| 15              | (A1)             | (RKK 3G1.5)             | (MV1)           | (MAGNETVENTIL OPTION)/SOLENOID VALVE                            |      |
| 16              | (Box Argos)      | (RKK 5G1.5)             | (MV2) (M2)      | (MAGNETVENTIL KAPREG./F.D. START)/SOLENOID VALVE/DELAY START    |      |
| 20              | Box Argos        | 2G0.75                  | TS1             | TEMPERATUR PRODUKT/TEMPERATURE PRODUCT                          |      |
| 21              | Box Argos        | 2G0.75                  | LD1             | NIVÅ DISK/LEVEL WASHING   |      |
| 22              | Box Argos        | 2G0.75                  | LD2             | NIVÅ DISKMEDEL-DESINFEKTION/LEVEL DETERGENT-DESINFECTION        |      |
| 23              | Box Argos        | 2G0.75                  | ACI             | PUMP DESINFEKTION/PUMP DESINFECTION                             |      |
| 24              | Box Argos        | 2G0.75                  | DET             | PUMP DISKMEDEL/PUMP DETERGENT                                   |      |
| 25              |                  |                         |                 |   |      |
| 26              | Box Argos        | 2G0.75                  | EV 2            | MAGNETVENTIL VARMVATTEN/SOLENOID VALVE HOT WATER                |      |
| 27              | Box Argos        | 2G0.75                  | EV 3            | MAGNETVENTIL KALLVATTEN/SOLENOID VALVE COLD WATER               |      |
| 28              | Box Argos        | 3G0.75                  | EV 6            | MAGNETVENTIL DRÄNERING/SOLENOID VALVE DRAINAGE                  |      |

|  |          |       |           |        |                      |
|--|----------|-------|-----------|--------|----------------------|
| Ritad  | Datum    | Godk. | Stand.gr. | Skala  | Sammanst.r. i tn.nr. |
| tba  | 13-01-01 | AH    |           | .      | .                    |
| Box2003 för Argos styrning<br>Box2003 for Argos control<br>Kabellista/Cable list |          |       |           |        | Order nr.            |
|  |          |       |           |        | .                    |
|  |          |       |           |        | Ersätter             |
|  |          |       |           |        | Ersatt av            |
|  |          |       |           |        | .                    |
| <b>Wedholms</b><br>Wedholms AB   |          |       | Ref.nr.   | Utgåva | Ritn.Nr.             |
|  |          |       | .         | B      | 320656               |

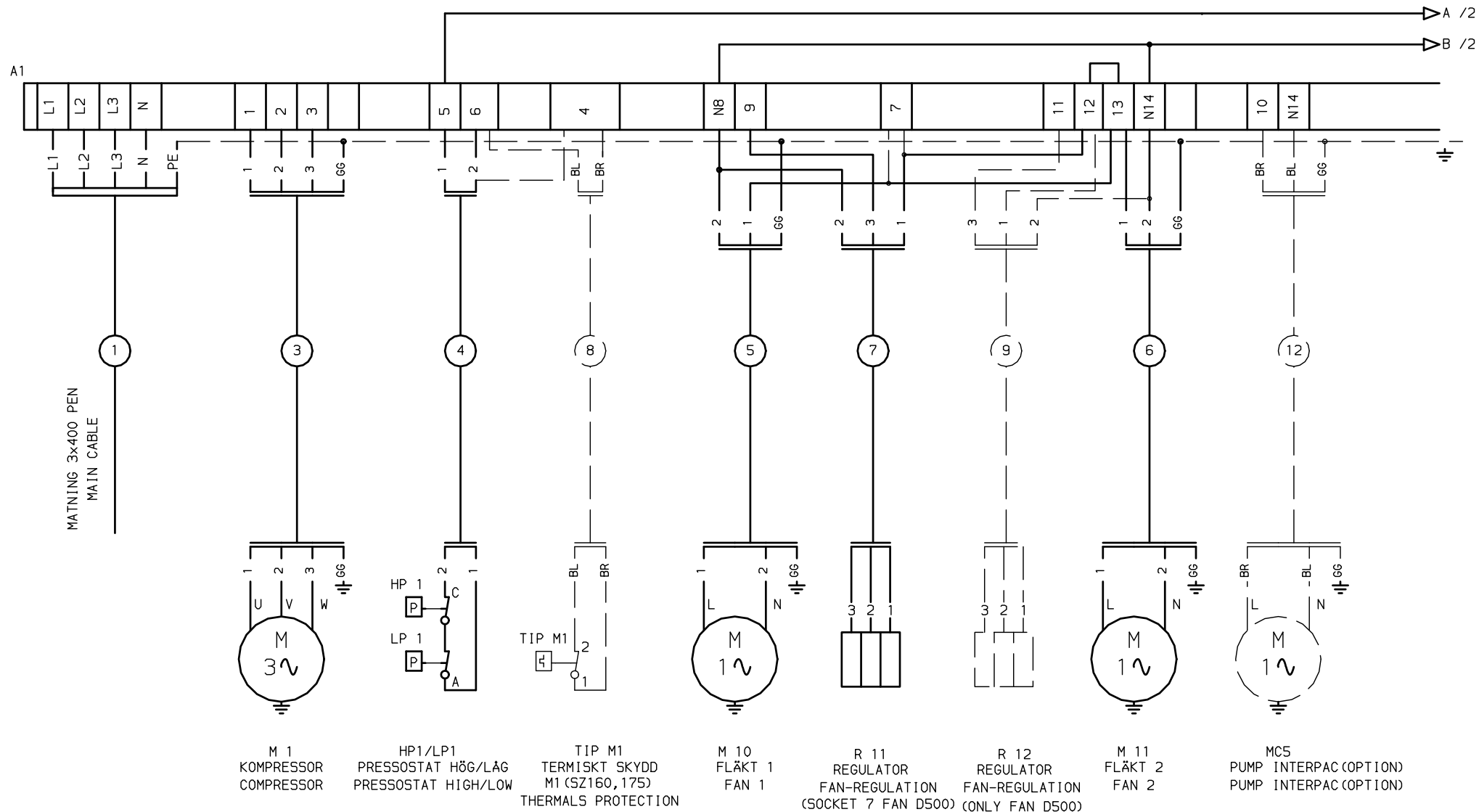

FÄRGKOD PARTER/COLOURS PARTS

- SV - SVART-BLACK
- BL - BLÅ-BLUE
- BR - BRUN-BROWN
- R - RÖD-RED
- V - VIT-WHITE
- G - GRÅ-GREY
- VI - VIOLETT-VIOLET
- RO - ROSA-PINK
- O - ORANGE-ORANGE
- GG - GUL/GRÖN-YELLOW/GREEN

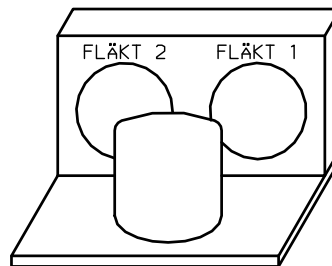

|   |                   |             |              |             |                    |
|---|-------------------|-------------|--------------|-------------|--------------------|
| Ritad<br>tba  | Datum<br>13-02-01 | Godk.<br>AH | Stand.gr.    | Skala<br>.  | Sammanst.ritn.nr.  |
| Box2003 för Argos styrning<br>Box2003 for Argos control<br>Yttre förbindning/Connection 1 (3) |                   |             |              |             | Order nr.<br>.     |
| Ersätter<br>.   |                   |             |              |             | Ersatt av<br>.     |
| <b>Wedholms</b><br>Wedholms AB  |                   |             | Ref.nr.<br>. | Utgåva<br>A | Ritn.Nr.<br>320657 |



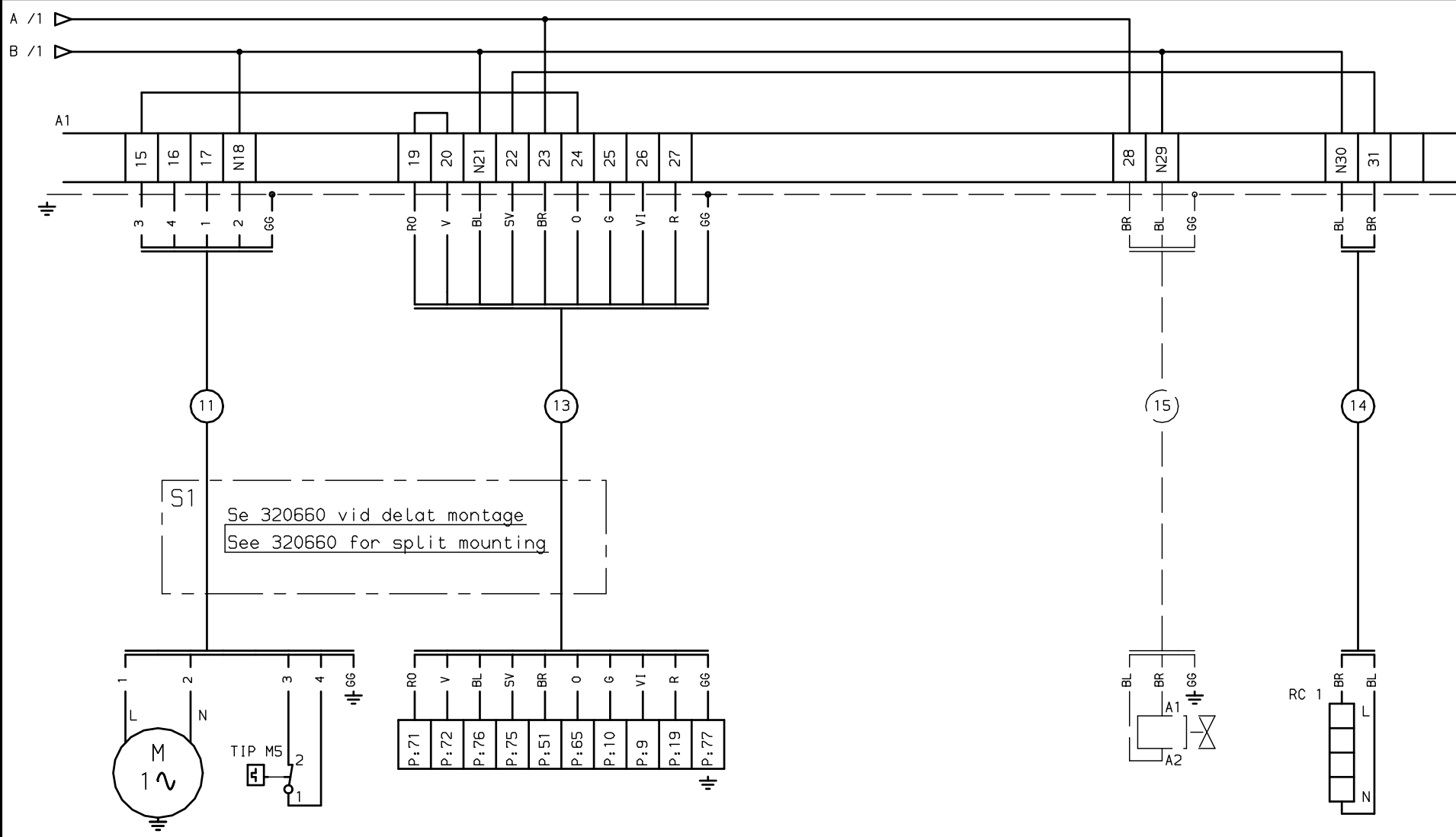

M 5  
DISKUMP  
CLEANING PUMP

TIP M5  
TERMISKT SKYDD DISKUMP  
THERMALS PROTECTION

TILL ARGOS  
TO ARGOS

MV1  
MAGNETVENTIL (OPTION)  
SOLENOID VALVE (OPTION)

RC1  
VEVHUSVÄRMARE  
CRANKCASE HEATER

FÄRGKOD PARTER/COLOURS PARTS

- SV - SVART-BLACK
- BL - BLÅ-BLUE
- BR - BRUN-BROWN
- R - RÖD-RED
- V - VIT-WHITE
- G - GRÅ-GREY
- VI - VIOLETT-VIOLET
- RO - ROSA-PINK
- O - ORANGE-ORANGE
- GG - GUL/GRÖN-YELLOW/GREEN

|  |                   |             |             |             |                         |
|--|-------------------|-------------|-------------|-------------|-------------------------|
| Ritad<br>tba   | Datum<br>13-02-01 | Godk.<br>AH | Stand.gr.   | Skala<br>.  | Sammanst.r.itn.nr.<br>. |
| Box2003 för Argos styrning<br>Box2003 for Argos control<br>Yttre förbindning/Connection 2(3) |                   |             |             |             | Order nr<br>.           |
| Ersätter<br>.  |                   |             |             |             | Ersatt av<br>.          |
| <b>Wedholms</b><br>Wedholms AB   |                   |             | Ref.nr<br>. | Utgåva<br>A | Ritn.Nr<br>320658       |

# BOX ARGOS

PANELKORT P7

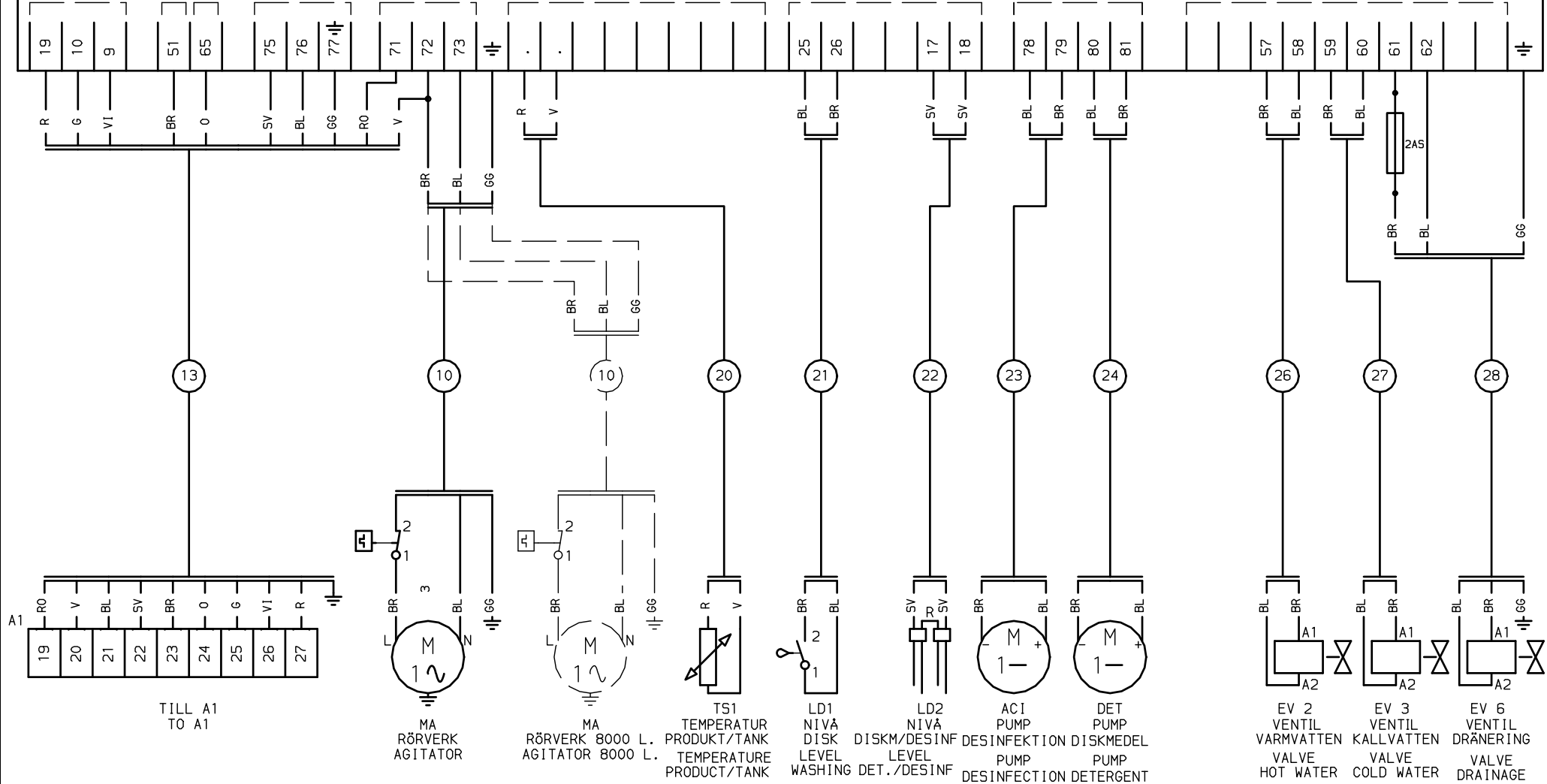

TILL A1  
TO A1

MA  
RÖRVERK  
AGITATOR

MA  
RÖRVERK 8000 L.  
AGITATOR

TS1  
TEMPERATUR  
PRODUKT/TANK  
TEMPERATURE  
PRODUCT/TANK

LD1  
NIVÅ  
DISK  
LEVEL  
WASHING

LD2  
NIVÅ  
DISK/DESINF  
LEVEL  
DET./DESINF

ACI  
PUMP  
DESINFEKTION  
PUMP

DET  
PUMP  
DISKMEDEL  
PUMP  
DESINFEKTION  
DETERGENT

EV 2  
VENTIL  
VARMVATTEN  
VALVE  
HOT WATER

EV 3  
VENTIL  
KALLVATTEN  
VALVE  
COLD WATER

EV 6  
VENTIL  
DRÄNERING  
VALVE  
DRAINAGE

FÄRGCOD PARTER/COLOURS PARTS

- SV - SVART-BLACK
- BL - BLÅ-BLUE
- BR - BRUN-BROWN
- R - RÖD-RED
- V - VIT-WHITE
- G - GRÅ-GREY
- VI - VIOLETT-VIOLET
- RO - ROSA-PINK
- O - ORANGE-ORANGE
- GG - GUL/GRÖN-YELLOW/GREEN

|  |                   |             |             |                |                   |
|--|-------------------|-------------|-------------|----------------|-------------------|
| Ritad<br>tba   | Datum<br>13-02-01 | Godk.<br>AH | Stand.gr.   | Skala<br>.     | Sammanst.ritn.nr. |
| Box2003 för Argos styrning<br>Box2003 for Argos control<br>Yttre förbindning/Connection 3(3) |                   |             |             |                | Order nr<br>.     |
| Ersätter<br>.  |                   |             |             | Ersatt av<br>. |                   |
| <b>Wedholms</b><br>Wedholms AB   |                   |             | Ref.nr<br>. | Utgåva<br>A    | Ritn.Nr<br>320659 |

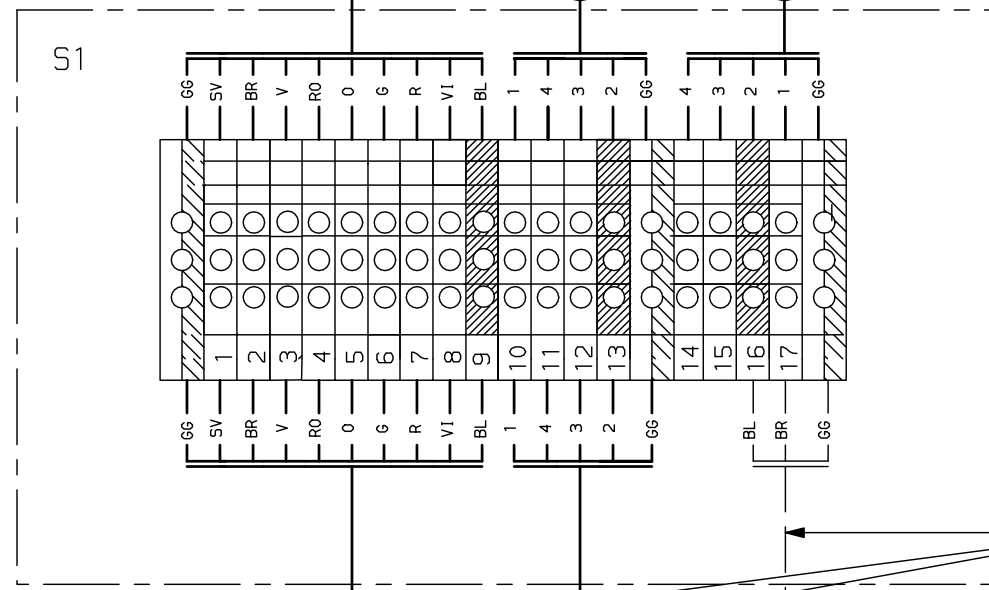
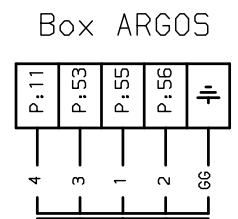
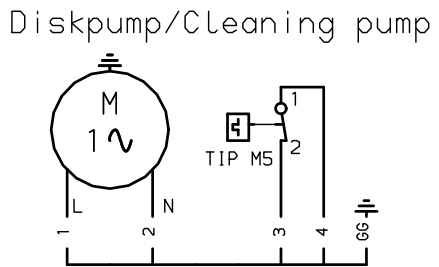
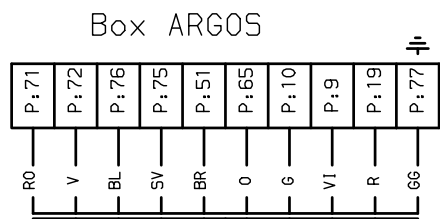

Skarvlåda S1 på bakre tankgavel  
Connection-box S1 rear end tank

- FÄRGKOD PARTER/COLOURS PARTS
- SV - SVART/BLACK
  - BL - BLÅ/BLUE
  - BR - BRUN/BROWN
  - R - RÖD/RED
  - V - VIT/WHITE
  - G - GRÅ/GREY
  - VI - VIOLETT/VIOLET
  - RO - ROSA/PINK
  - 0 - ORANGE/ORANGE
  - GG - GUL/GRÖN--YELLOW/GREEN

Platsmontage (Kablar medlevereras)  
Cables mounted at installation  
Cables supplied by manufacturer

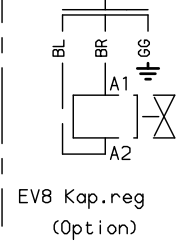
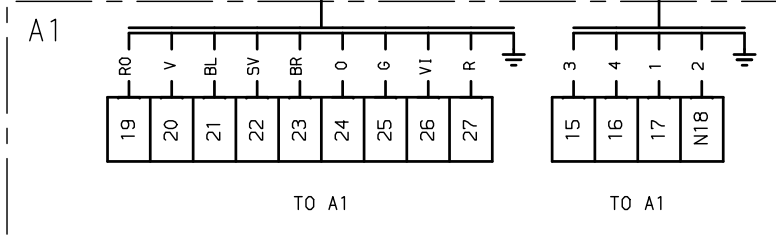

ELDOKUMENTATION/DOCUMENTATION  
ENL. 320650-320660

|   |                   |             |             |                     |                     |
|---|-------------------|-------------|-------------|---------------------|---------------------|
| Ritad<br>tba  | Datum<br>13-02-01 | Godk.<br>AH | Stand. gr.  | Skala               | Sammanst. ritn. nr. |
| Box2003 för Argos styrning<br>Box2003 for Argos control<br>Skarvlåda DF95/Connection-box DF95 |                   |             |             |                     | Order nr.           |
| Ersätter  |                   |             |             |                     | Ersatt av           |
| <b>Wedholms</b><br>Wedholms AB  |                   | Ref. nr.    | Utgåva<br>B | Ritn. Nr.<br>320660 |                     |